

Super Caliper-Solar Powered

SERIES 500 — No battery or origin reset needed for IP67 Digital Caliper

FEATURES

- With no annoying origin restoration necessary, a measurement can be started any time and there is no restriction on operating speed.
- World's unique* solar-powered Super Caliper that is eco-friendly with no battery.
*According to Mitutoyo investigation in January, 2005
- The impact resistance of the display unit has been increased for improved usability in workshop conditions.
- IP67 protection assures waterproof reliability.
- This Super Caliper uses components that do not contain harmful substances and is compatible with RoHS Directives.
- Supplied in fitted plastic case.

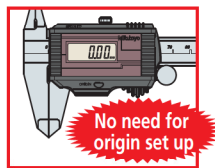
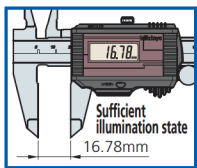
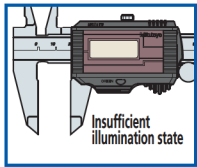

Improvement in surface finish of beam

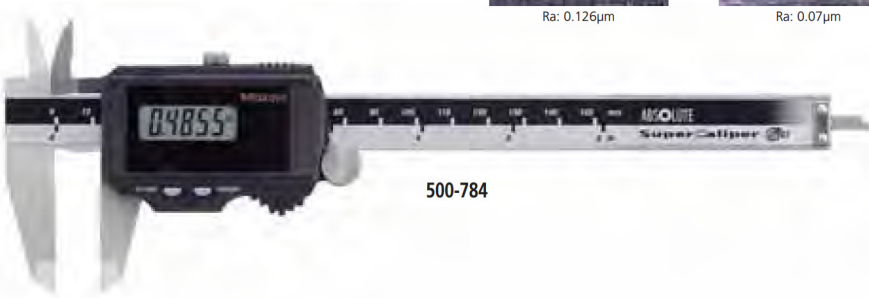
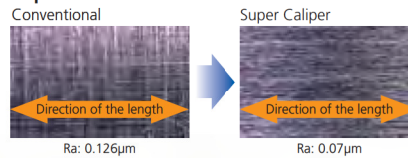

500-784

SPECIFICATIONS

Metric			
Range	Order No.	Accuracy	Resolution
0 - 150mm	500-776	±0.02mm	0.01mm
0 - 150mm	500-774*	±0.02mm	0.01mm
0 - 200mm	500-777	±0.02mm	0.01mm
0 - 200mm	500-775*	±0.02mm	0.01mm

*Without SPC data output

Inch/Metric			
Range	Order No.	Accuracy	Resolution
0 - 6" / 0 - 150mm	500-786	±.001"	.0005" / 0.01mm
0 - 6" / 0 - 150mm	500-784*	±.001"	.0005" / 0.01mm
0 - 8" / 0 - 200mm	500-787	±.001"	.0005" / 0.01mm
0 - 8" / 0 - 200mm	500-785*	±.001"	.0005" / 0.01mm

*Without SPC data output

DIMENSIONS AND MASS

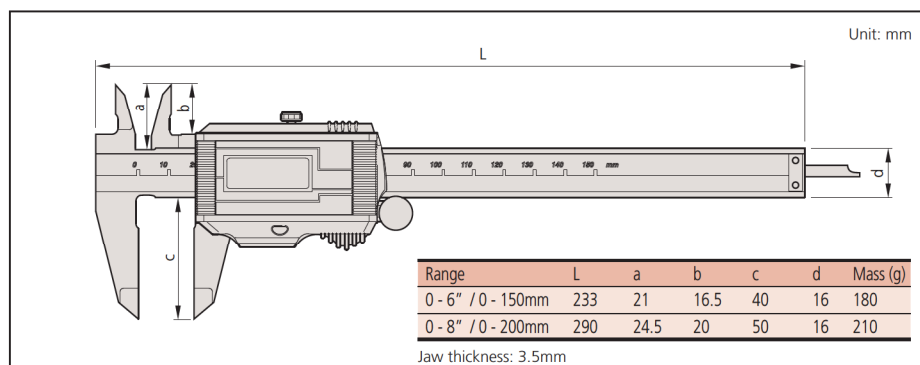

Technical Data

Accuracy: Refer to the list of specifications
 Resolution: .0005" / 0.01mm or 0.01mm
 Repeatability: .0005" / 0.01mm
 Display: LCD
 Length standard: ABSOLUTE electromagnetic induction linear encoder
 Max. response speed: Unlimited
 Battery: Solar battery*
 Dust/Water protection level: IP67
 *Can be used continuously above 60 lux ambient illumination.

Function

Origin-set, inch/mm conversion (on inch/metric models only)
 Alarm: Counting value composition error

Optional Accessories

- 05CZA624:** SPC cable with data switch (40" / 1m)
- 05CZA625:** SPC cable with data switch (80" / 2m)

IP67 protection level

Level 6: Dust-tight
 No ingress of dust.
 Level 7: Protected against the effects of temporary immersion in water.
 Ingress of water in quantities causing harmful effects shall not be possible when the enclosure is temporarily immersed 1 meter in water under standardized conditions of pressure and time (30 min.).

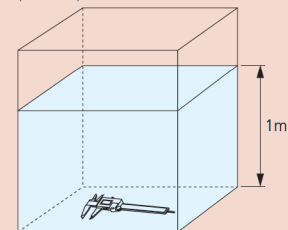

About the charge function (Super Caliper)

The minimum illumination required in the uncharged state is 60 lux. As shown in the table 'JIS Z 9110 Artificial Illumination Intensity Standard', this Super Caliper can be used without problems in a normal work environment.

The charge function allows the operator to use this Super Caliper without interrupting work even if the ambient illumination is temporarily insufficient.

- In the fully charged state this Super Caliper can operate for approximately an hour in an environment of 50lux illumination (less than the minimum necessary illumination intensity).
- The time necessary for full charge differs, depending on the charging conditions. If this Super Caliper is left unused in an illumination of 500 lux (usual for manufacturing environments), it takes approximately one hour to reach full charge.